

MASTER PART MARK	VIN	AVAILABLE THICKNESS	YIELD MIN.	BLANK LENGTH	BLANK WIDTH	WEIGHT (LBS)
BCH12	A	1.000	55 KSI	12.00	8.00	27.20

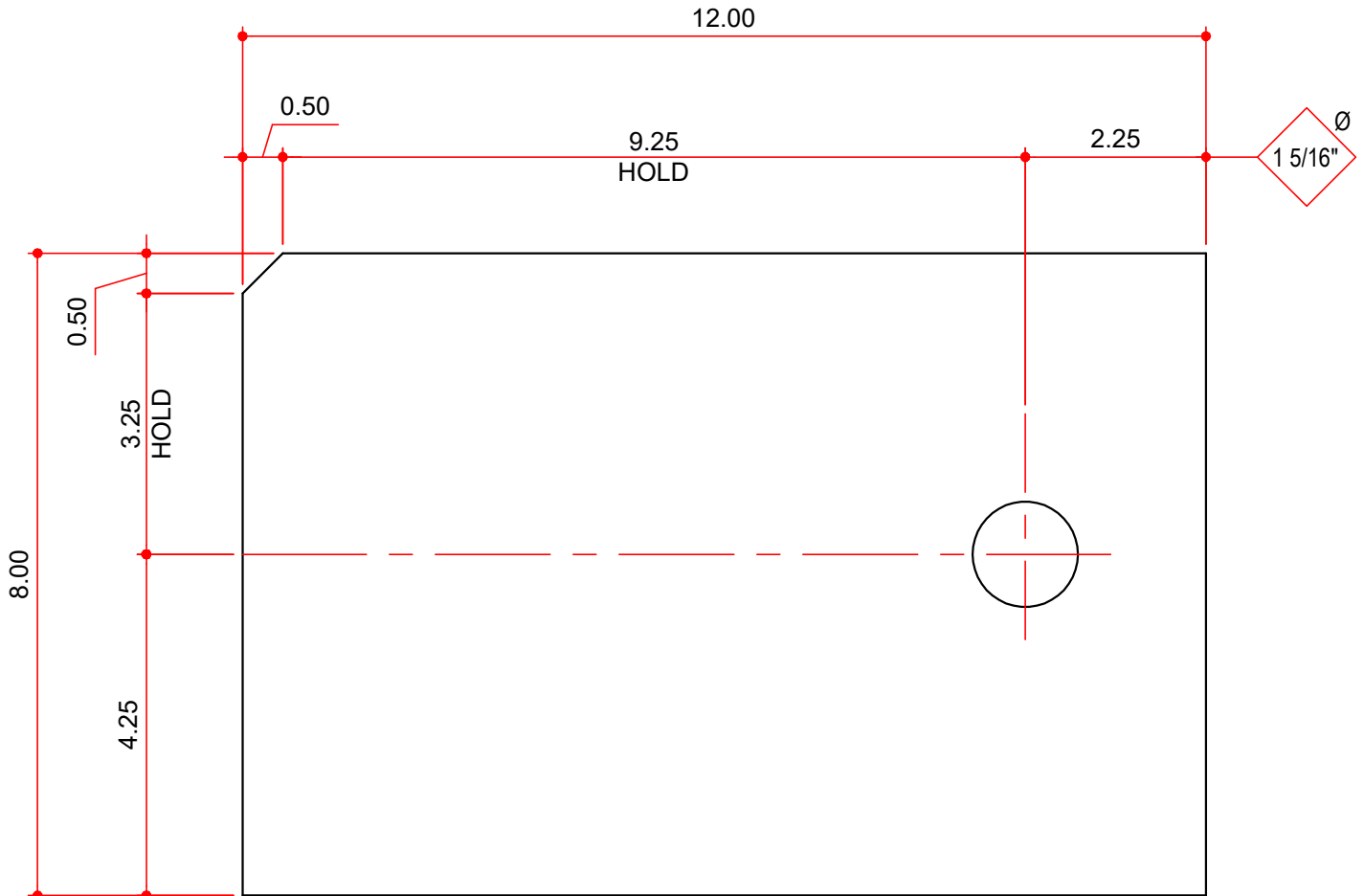

NOTES:

1) USED FOR DOUBLE ROD BRACING ONLY.

AVAILABLE COLORS

GP, HD, RP