

MASTER PART MARK	VIN	AVAILABLE THICKNESS	YIELD MIN.	BLANK LENGTH	BLANK WIDTH	WEIGHT (LBS)
GCB01	D	N/A	N/A	N/A	N/A	2.54
SUB PART MARK	VIN	AVAILABLE THICKNESS	YIELD MIN.	BLANK LENGTH	BLANK WIDTH	WEIGHT (LBS)
PART-A	NA	0.150	55 KSI	9.25	5.00	1.97
PART-B	NA	0.150	55 KSI	2.25	6.00	0.57

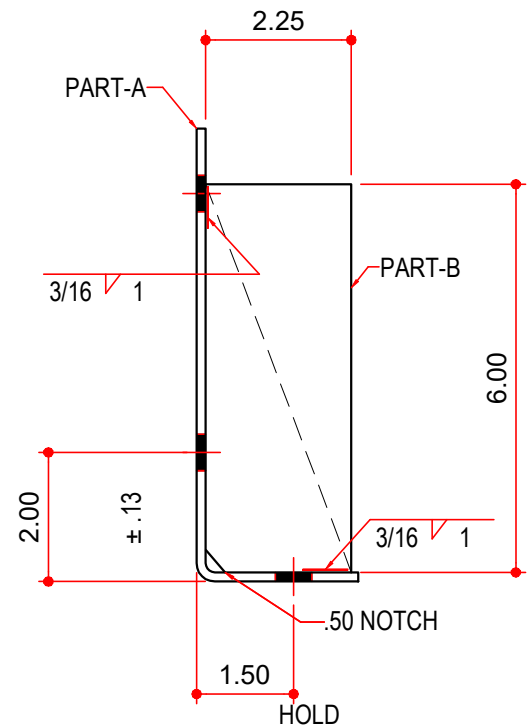
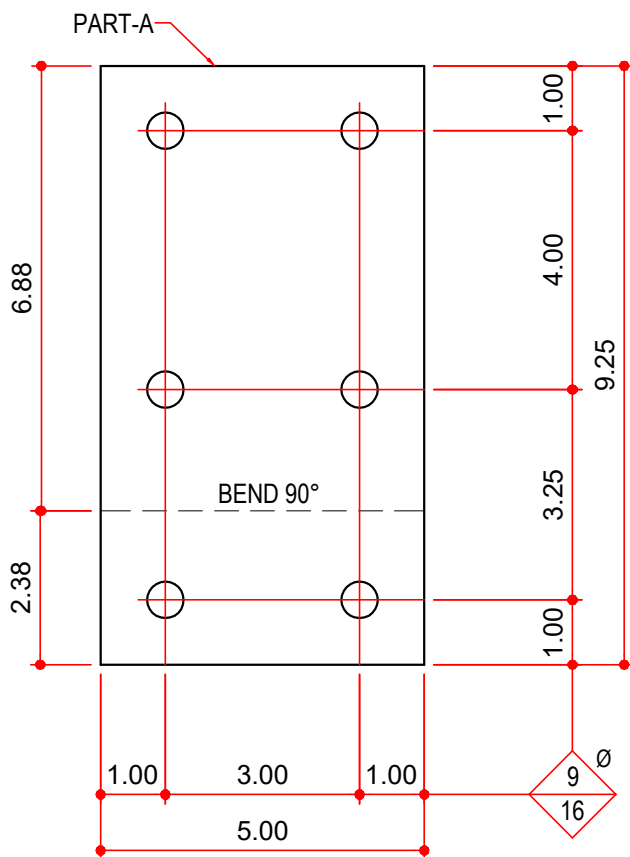

**NOTES:**

- 1) ALL WELD PER AWS STANDARDS.
- 2) GUSSET INFORMATION NOTE:
  - A) FULL GUSSET IS THE STANDARD
  - B) ALTERNATE OPTION TO PROVIDE A HALF GUSSET IS ACCEPTABLE BY DESIGN.
- 3) GUSSET PLATE TOLERNCES:
  - A) WIDTH (+0.0, -0.25)
  - B) LENGTH: 6.00 (+0.50, -0.50)

**AVAILABLE COLORS**

GP, HD, RP